

DALLAS 21

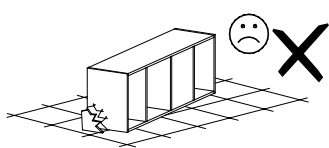

Narzędzia potrzebne do montażu

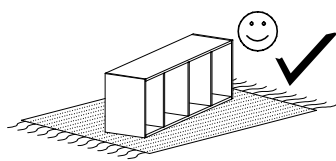
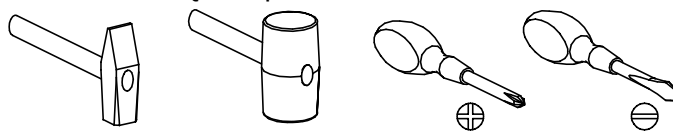

UWAGA !!!

MONTOWANIE USZKODZONYCH
ELEMENTÓW POWODUJE UTRATĘ
GWARANCJI

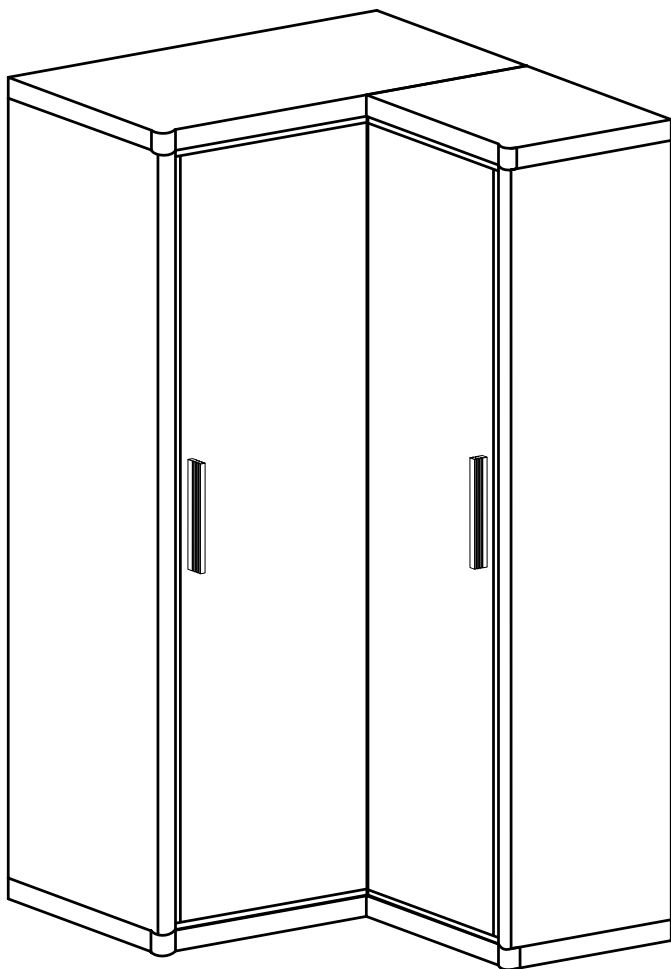

Nr	D[mm]	S[mm]	G[mm]	Ilość
1	553	450	48	1
2	1000	590	48	1
3	1000	590	48	1
4	553	450	48	1
5	1810	423	16	1
6	1810	562	16	1
7	1810	100	32	1
8	1810	100	32	1
9	1810	435	16	1
10	1810	400	16	1
11	966	400	16	1
12	966	80	16	1
13	548	380	16	4
14	1835	990	2,5	1
15	1835	840	2,5	1
16	1780	463	16	1
17	1780	463	16	1

W przypadku reklamacji proszę podać numer pakowacza znajdujący się na kartonie.

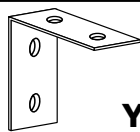

Y - 1 St.

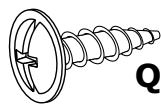

Q - 2 St.
3,5x16 mm



X1 - 38 St.



X2 - 2 St.

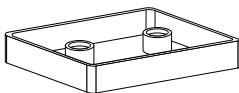

A - 7 St.

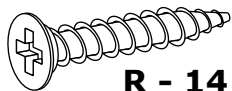

R - 14 St.
3,9x25 mm



M - 1 St.

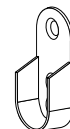

T - 2 St.

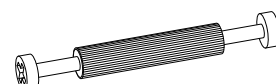

F - 6 St.

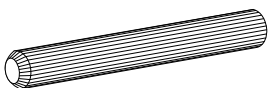

S - 6 St.

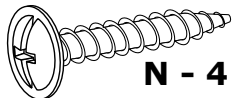

N - 4 St.
4x27 mm



U - 2 St.

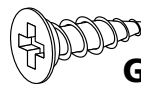

G - 37 St.
3,5x16 mm



L - 38 St.

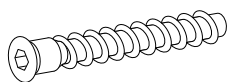

W - 2 St.

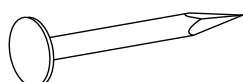

E - 100 St.

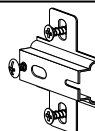

C - 8 St.

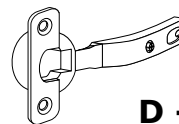

D - 4 St.



Z - 1 St.

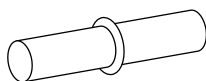

P - 20 St.

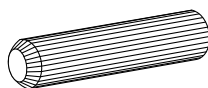

B - 20 St.

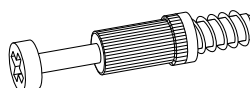

K - 26 St.

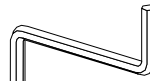

Z - 1 St.

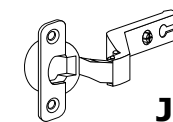

J - 4 St.

I

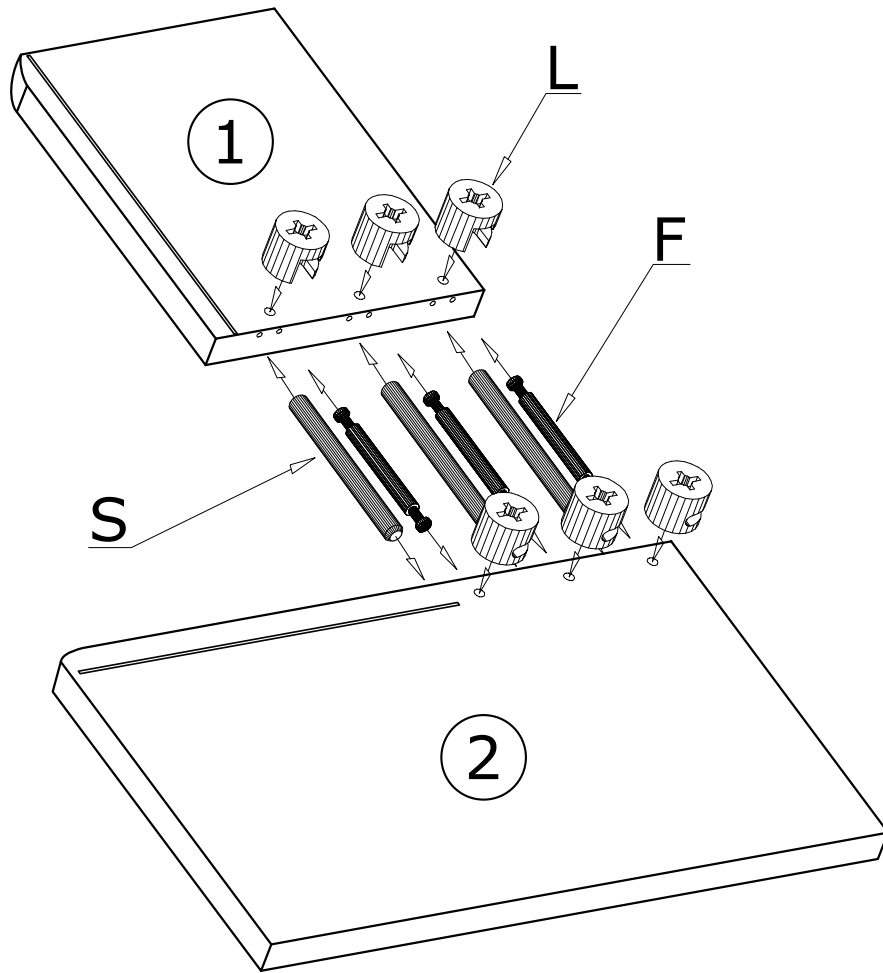

II

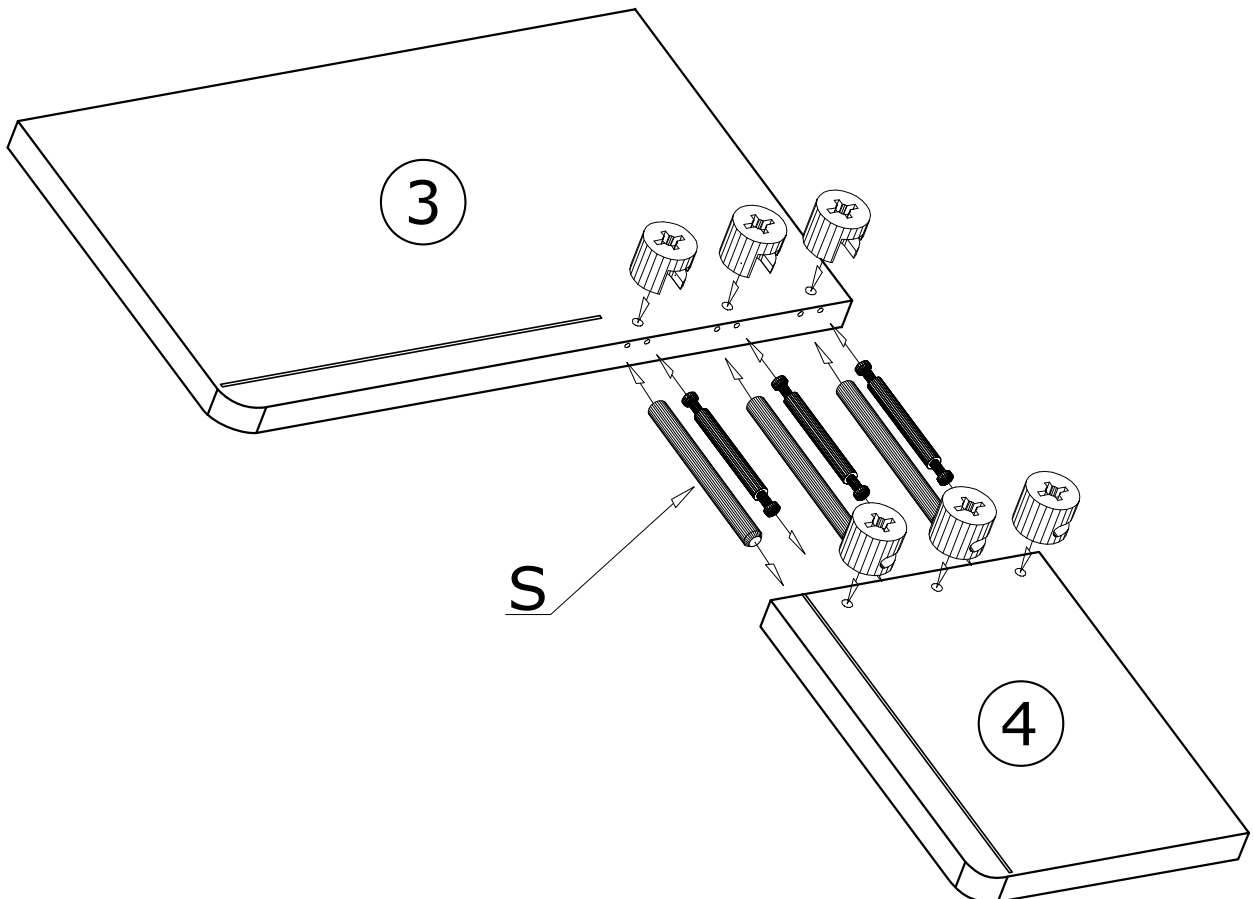

III

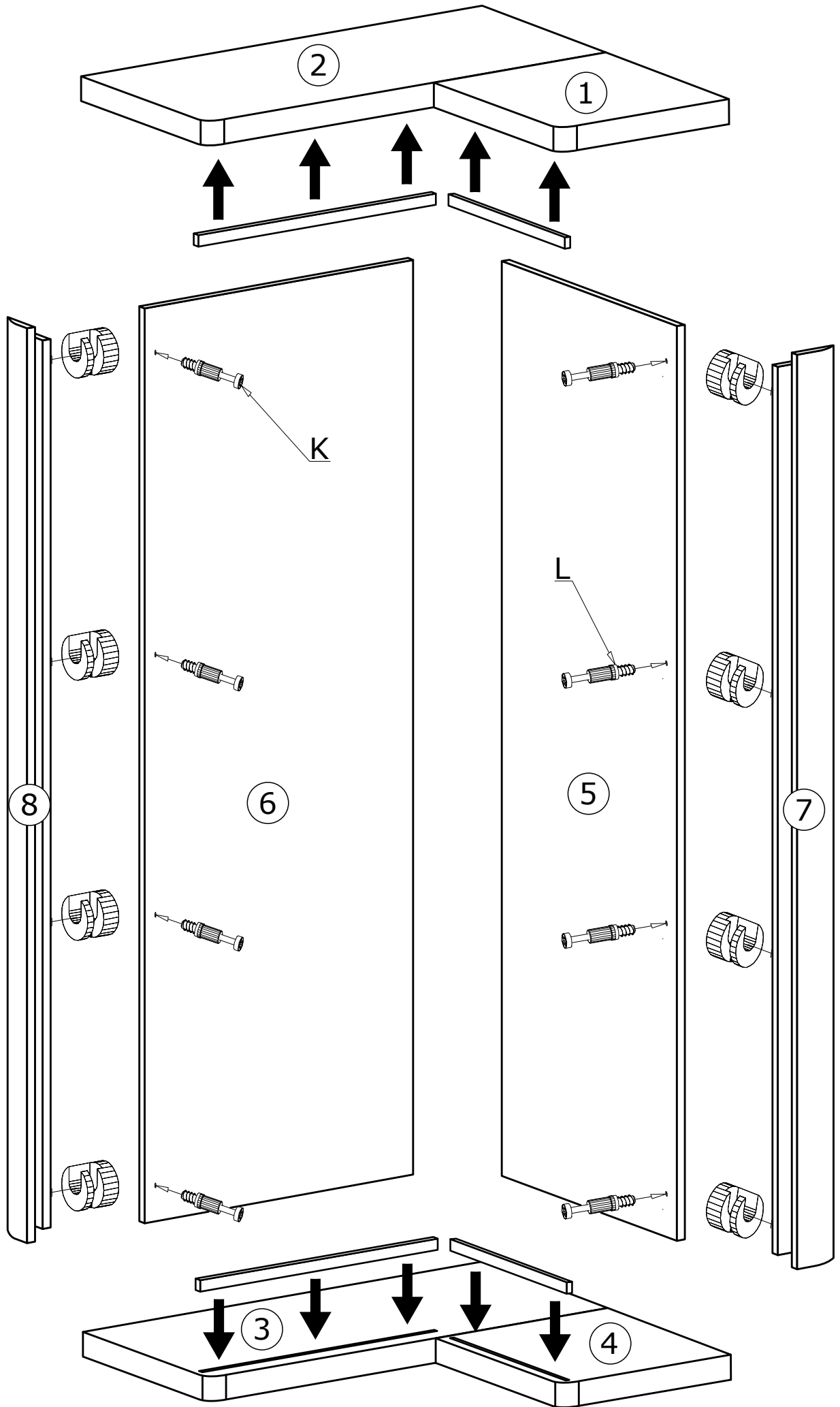

IV

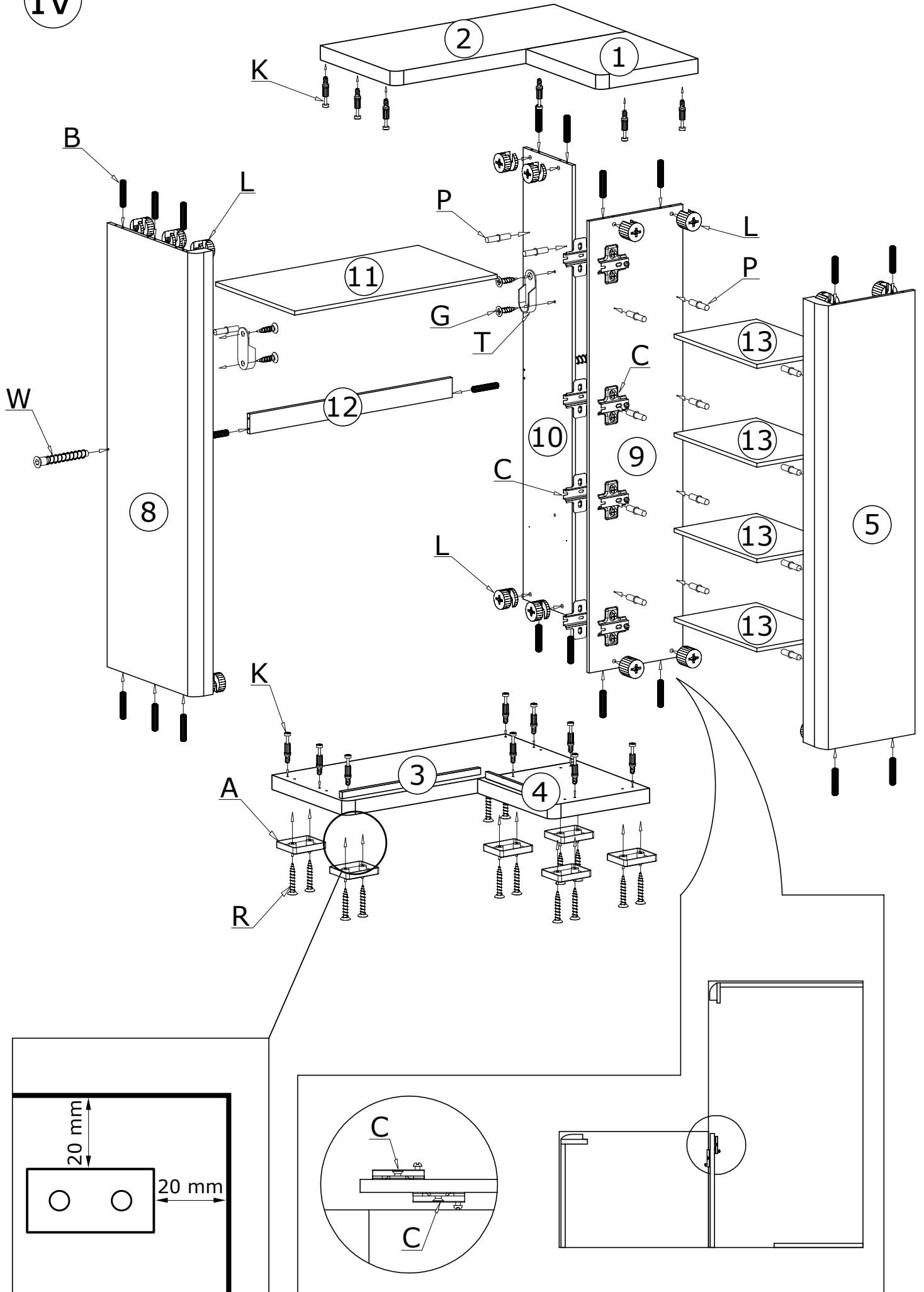

V

100X 

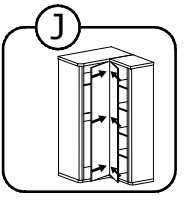
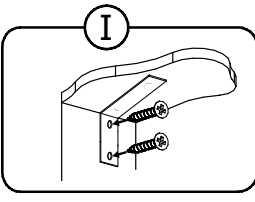
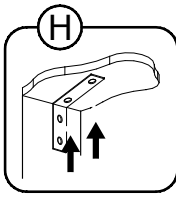
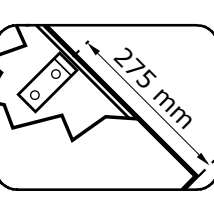
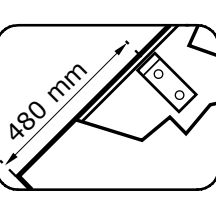
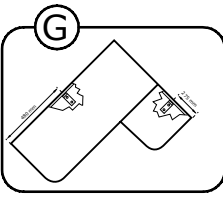
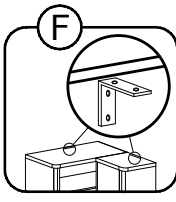
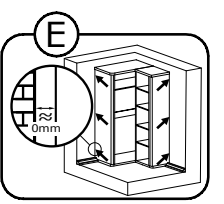
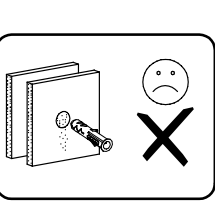
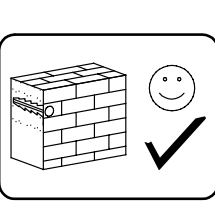
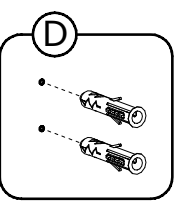
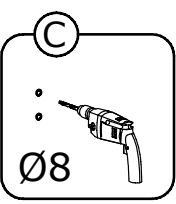
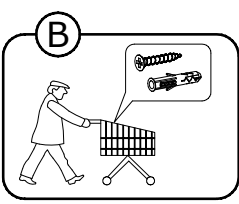
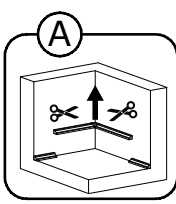
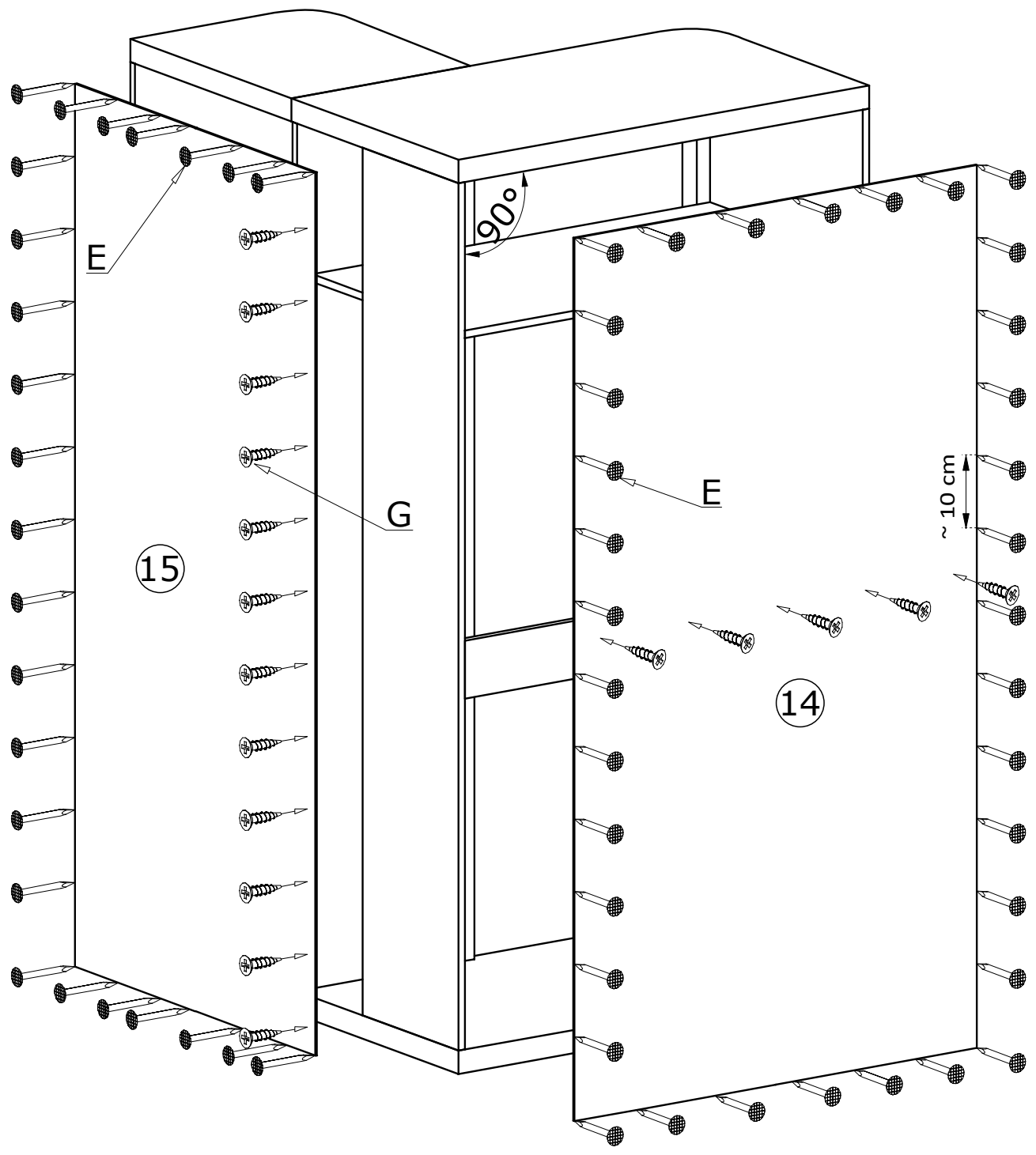

VI

