

# DALLAS 16

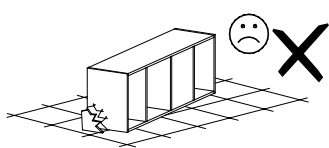

Narzędzia potrzebne do montażu

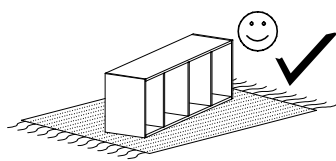
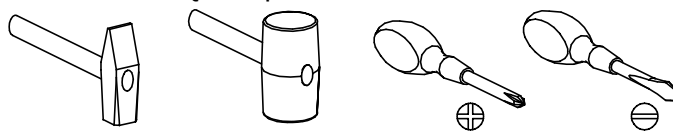

LEWA

PRAWA

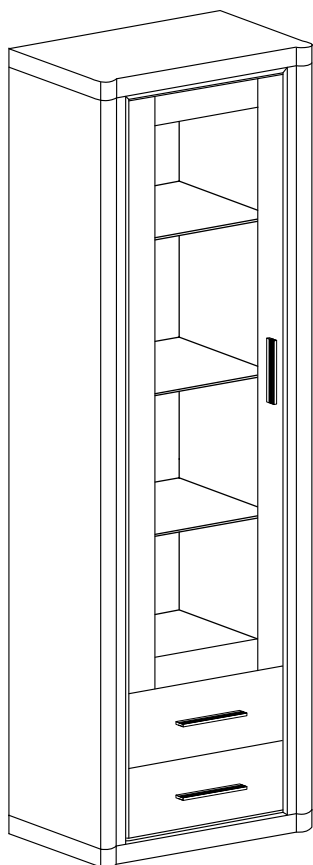

LUB

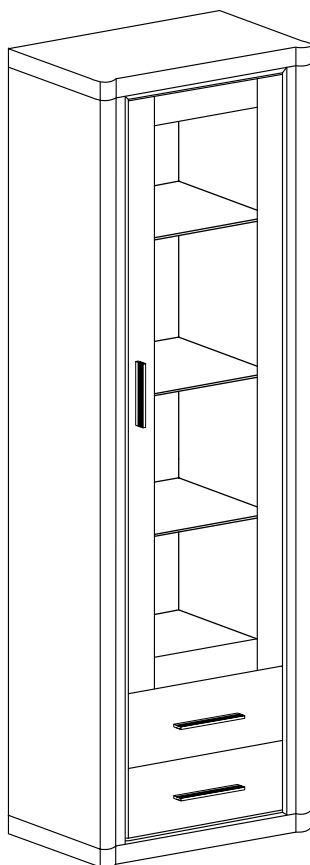

**UWAGA !!!**

MONTOWANIE USZKODZONYCH  
ELEMENTÓW POWODUJE UTRATĘ  
GWARANCJI

Nr	D[mm]	S[mm]	G[mm]	Ilość
1	580	450	48	1
2	580	450	48	1
3	540	25	16	2
4	1810	422	16	1
5	1810	422	16	1
6	1810	100	32	1
7	1810	100	32	1
8	395	405	16	1
9	395	405	16	1
10	545	405	16	1
11	1835	286	2,5	1
12	380	190	16	2
13	400	150	16	2
14	400	150	16	2
15	305	150	16	2
16	334	405	2,5	2
17	1430	380	16	1
18	542	350	4	3

W przypadku reklamacji proszę podać numer pakowacza znajdujący się na kartonie.

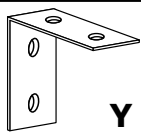

**Y - 1 St.**



**X1 - 20 St.**



**X2 - 4 St.**



**X3 - 2 St.**  
Ø5 mm

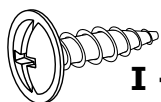

**I - 2 St.**  
3,5x16 mm

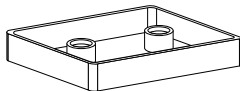

**A - 4 St.**

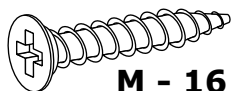

**M - 16 St.**  
3,9x25 mm

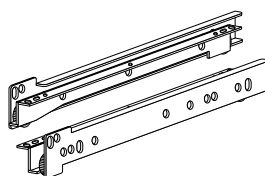

**T - 2 Kpl.**

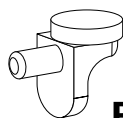

**P - 12 St.**

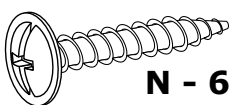

**N - 6 St.**  
4x27 mm

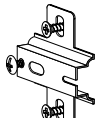

**C - 3 St.**

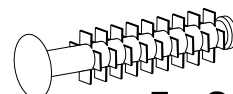

**F - 8 St.**

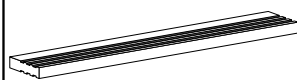

**U - 3 St.**

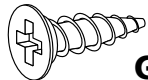

**G - 6 St.**  
3,5x16 mm

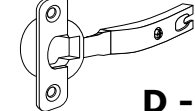

**D - 3 St.**

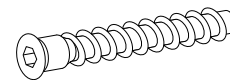

**W - 4 St.**



**L - 20 St.**



**E - 50 St.**

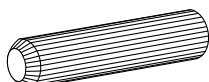

**B - 24 St.**

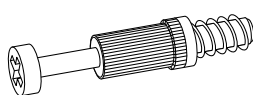

**K - 20 St.**

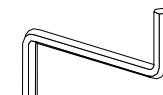

**Z - 1 St.**

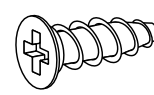

**J - 8 St.**  
5x13 mm

I

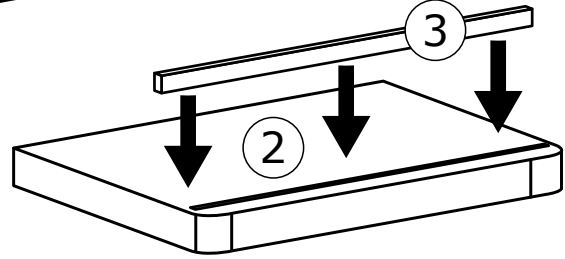
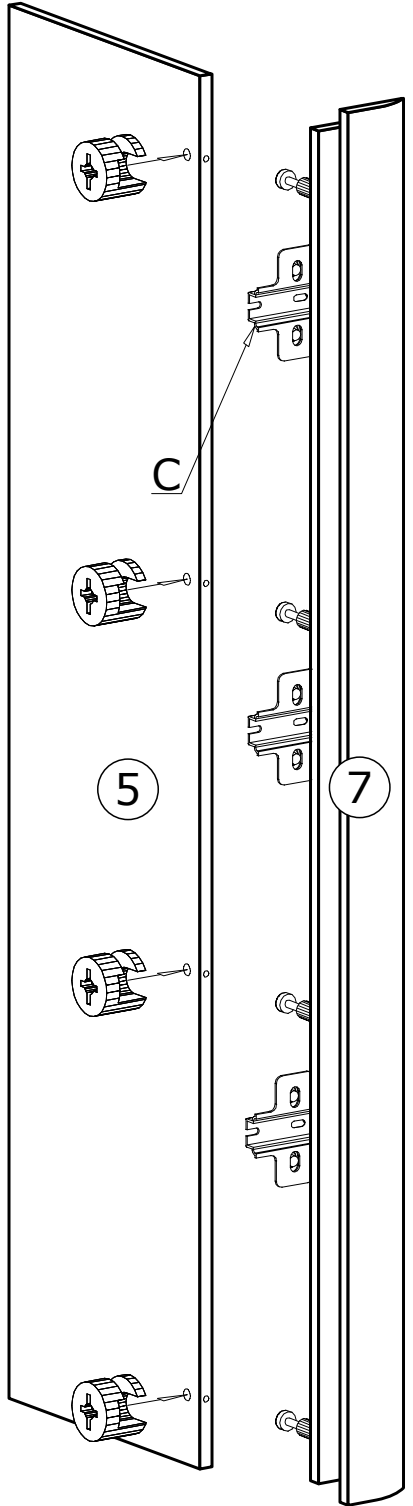
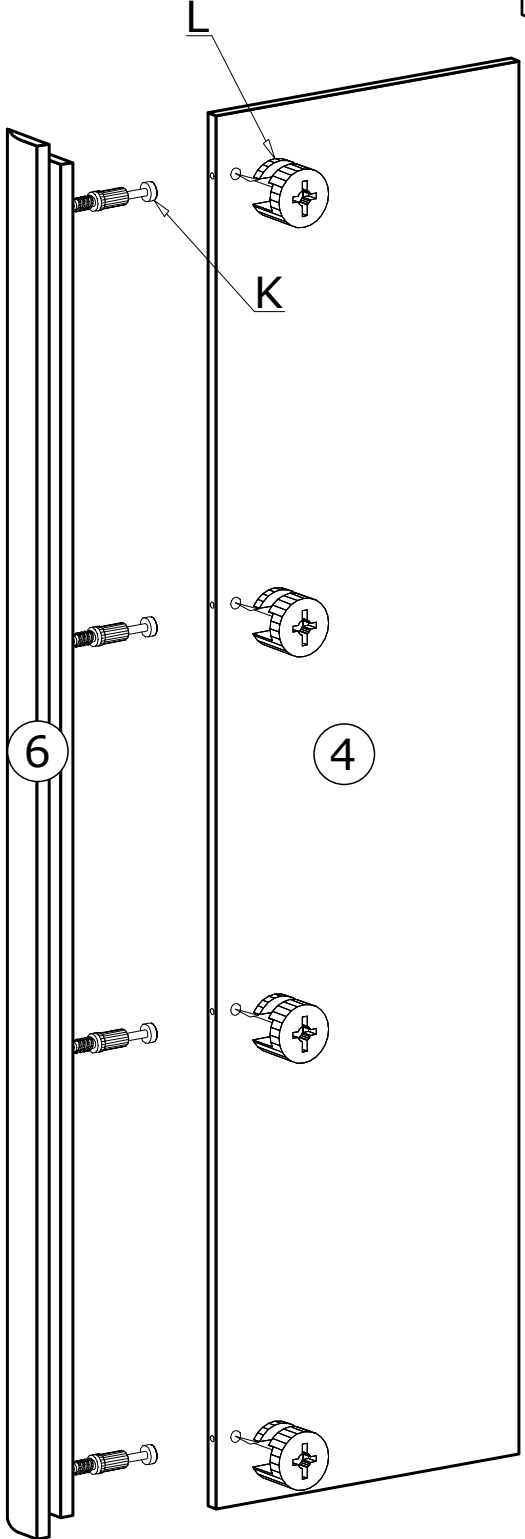
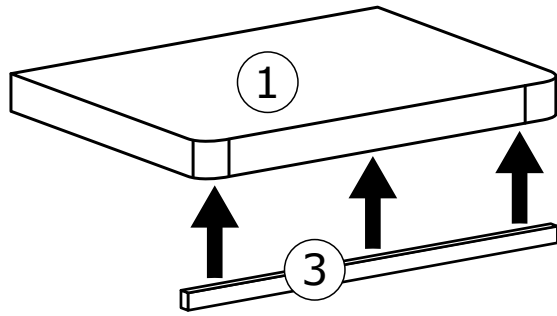

III

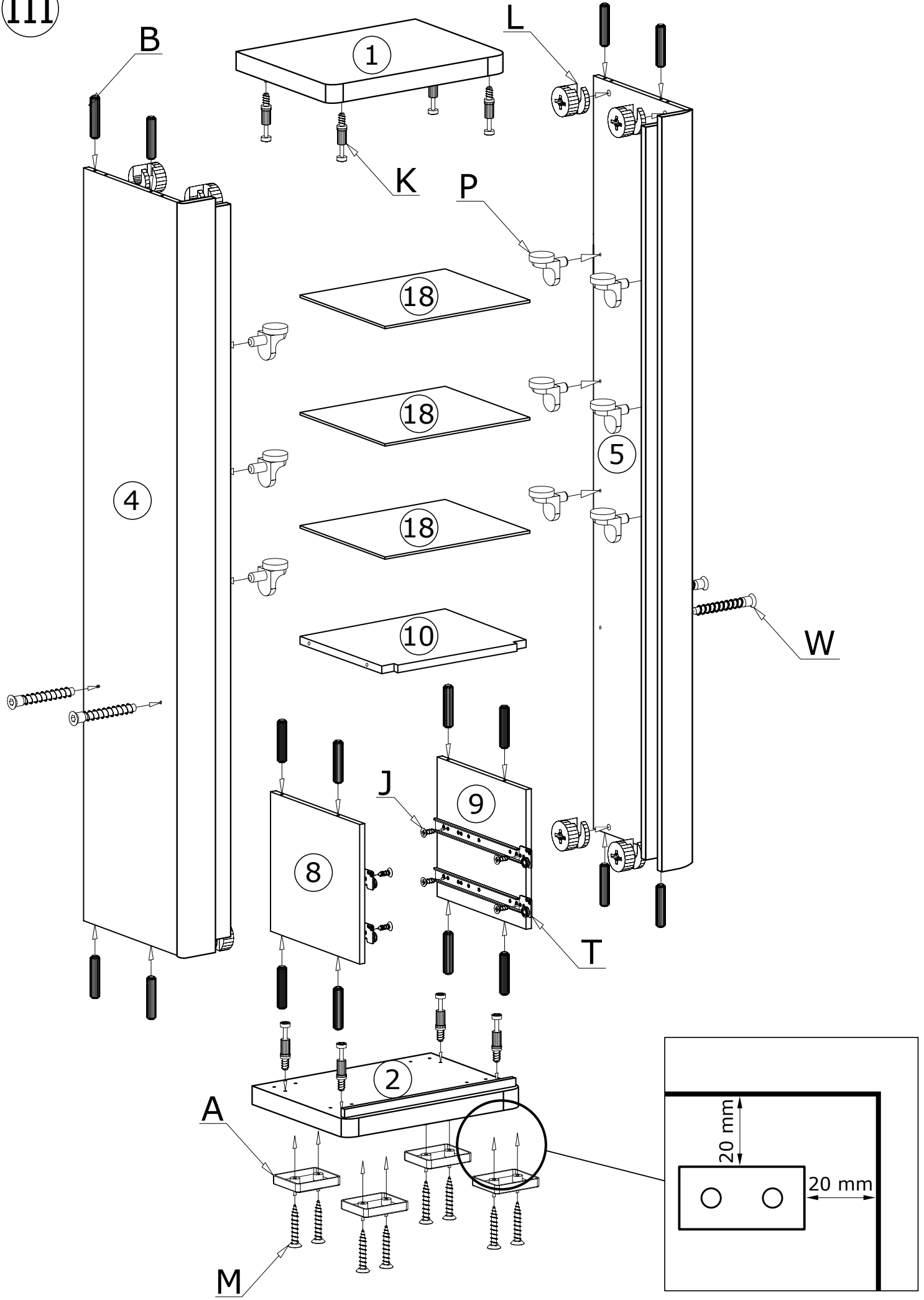

III

50X 

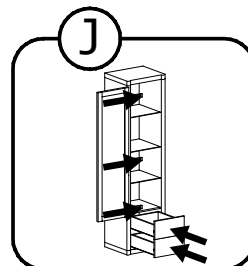
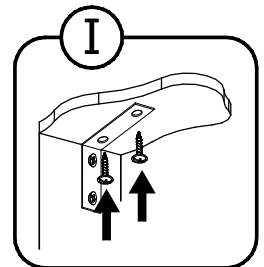
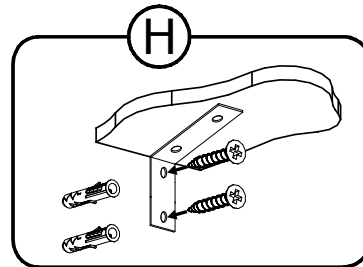
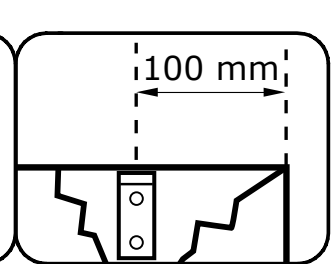
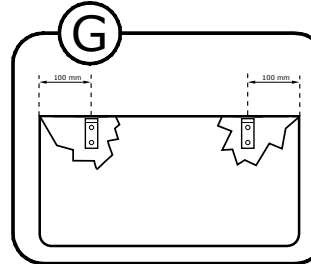
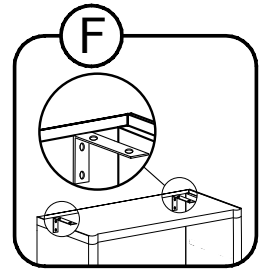
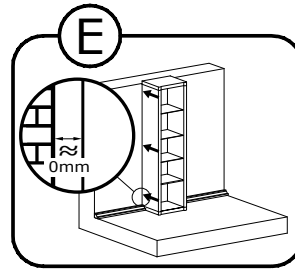
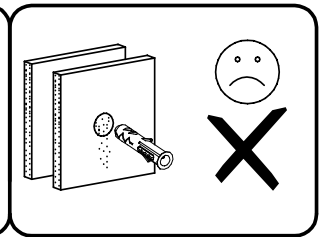
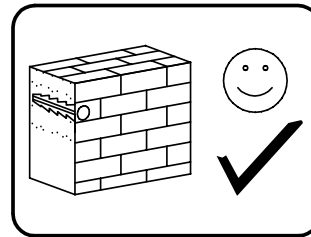
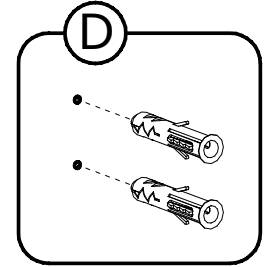
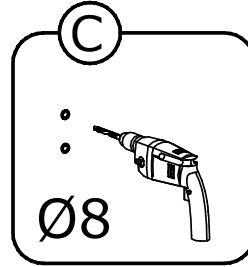
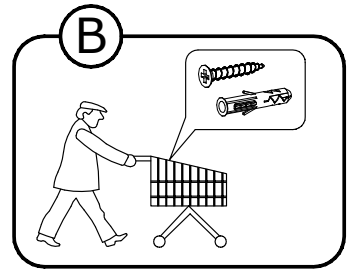
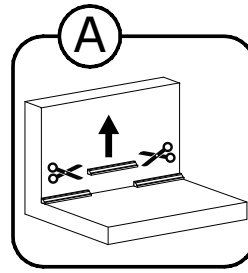
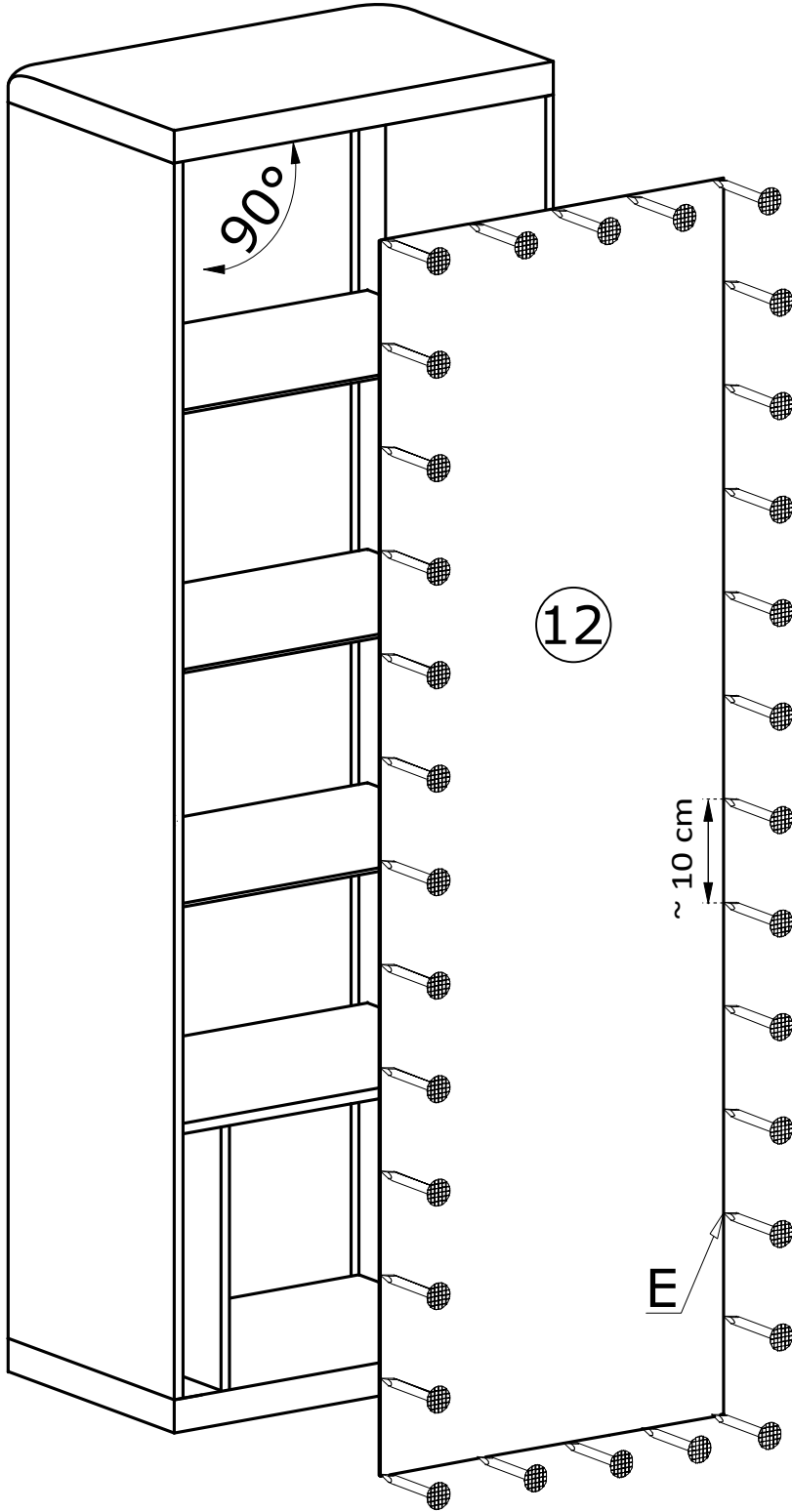

IV

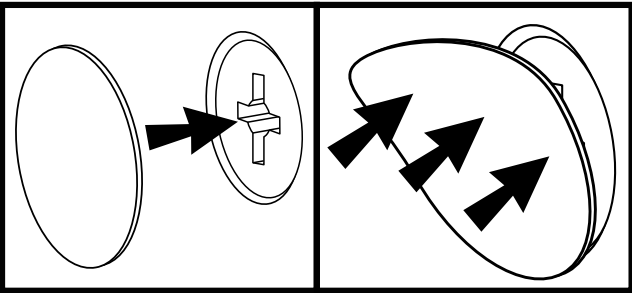
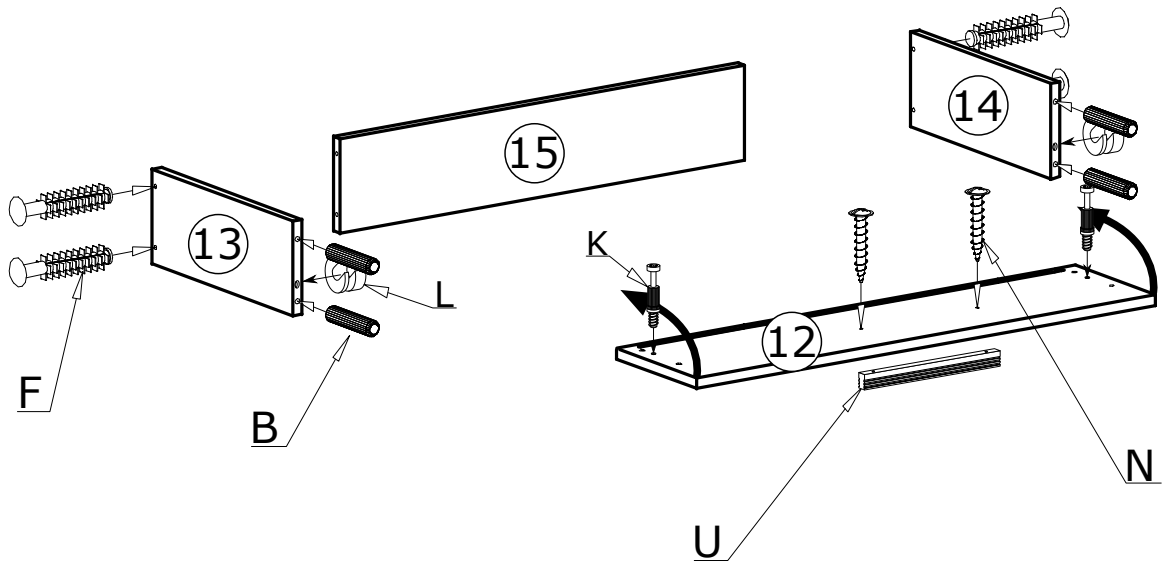

V

PRAWA

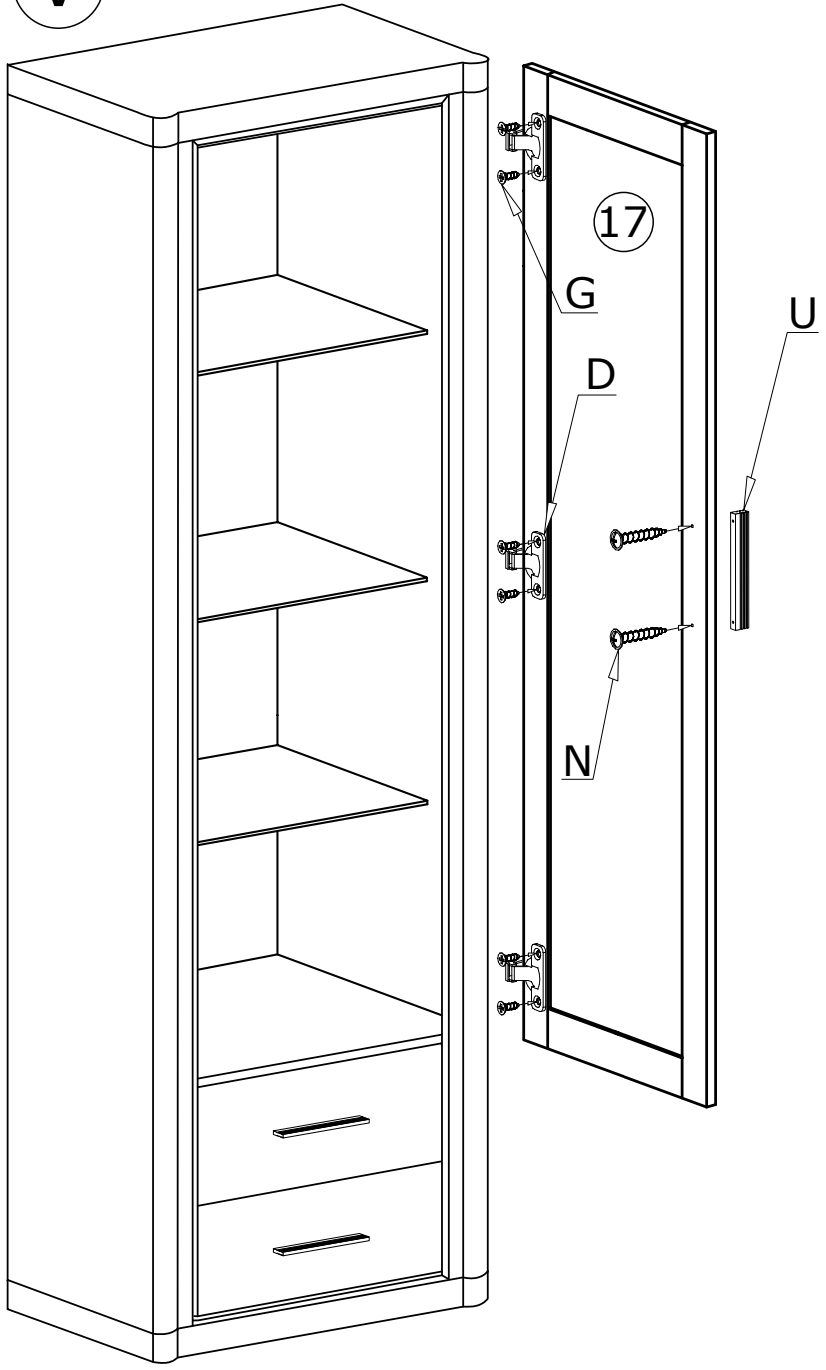
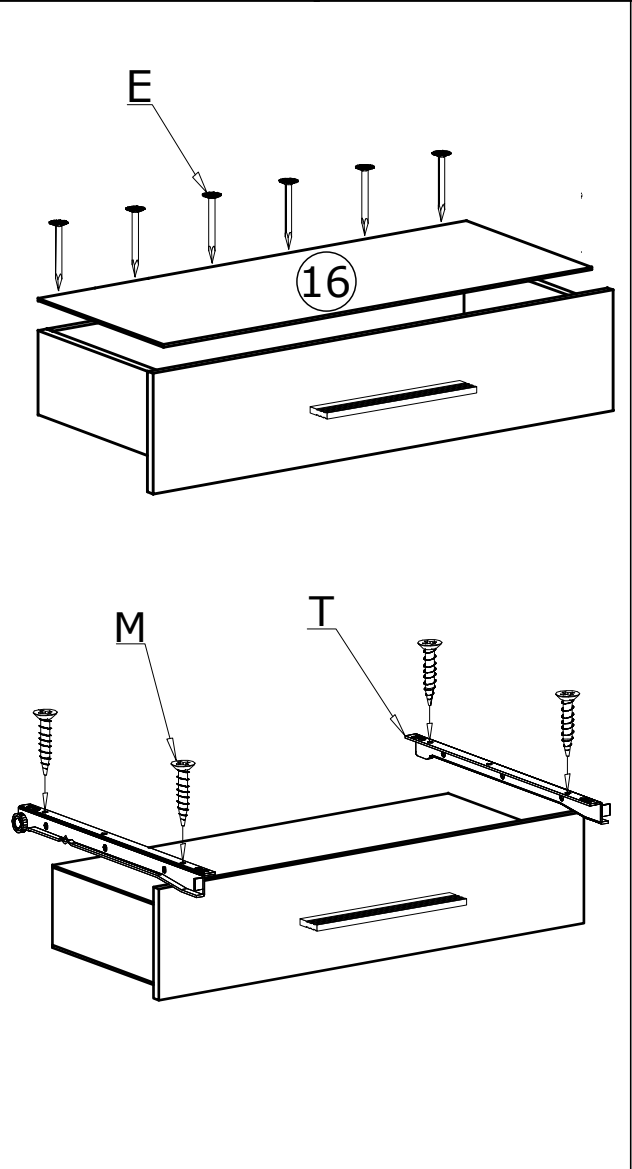

V

LEWA

