

KORA 7

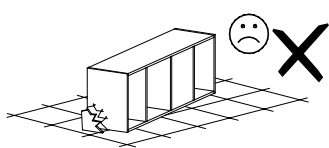

Narzędzia potrzebne do montażu

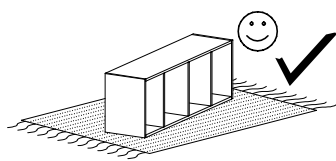
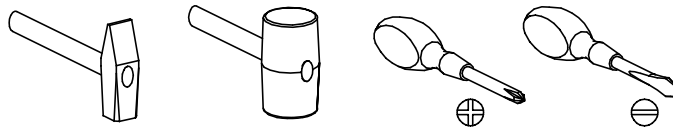

UWAGA !!!

MONTOWANIE USZKODZONYCH
ELEMENTÓW POWODUJE UTRATĘ
GWARANCJI

Nr	D[mm]	S[mm]	G[mm]	Ilość
1	1607	450	65	1
2	1607	450	65	1
3	830	410	16	1
4	830	410	16	1
5	830	410	16	1
6	830	410	16	1
7	1537	852	2,5	1
8	432	380	16	2
9	770	450	16	1
10	770	450	16	1
11	635	190	16	4
12	350	150	16	4
13	350	150	16	4
14	560	150	16	4
15	590	355	2,5	4

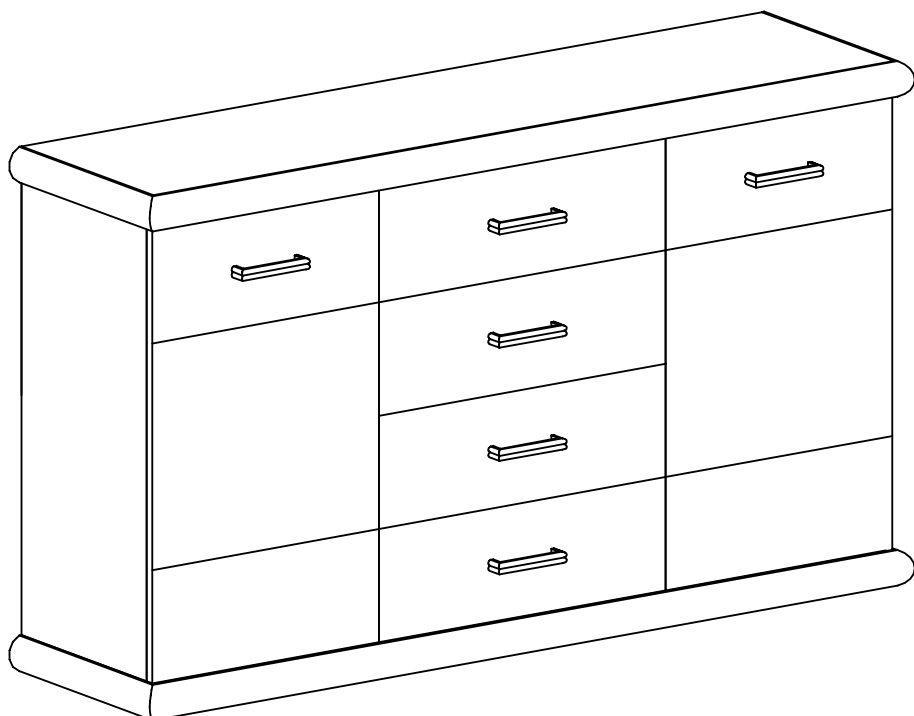

UWAGA !!!

Mebel zawiera
elementy drewniane

W przypadku reklamacji proszę podać numer pakowacza znajdujący się na kartonie.



I - 8 St.

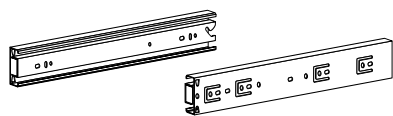

T - 4 Kpl.

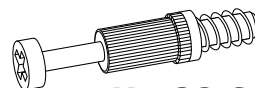

K - 32 St.

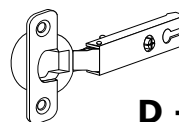

D - 4 St.

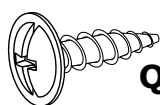

Q - 2 St.
3,5x16 mm

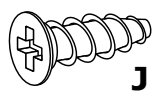

J - 32 St.
5x13 mm

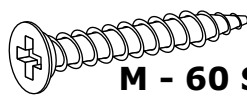

M - 60 St.
3x30 mm



F - 5 St.

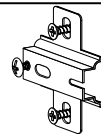

C - 4 St.

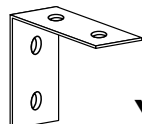

Y - 1 St.

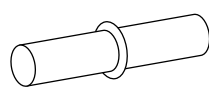

S - 8 St.



U - 6 St.

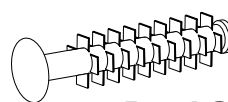

P - 16 St.

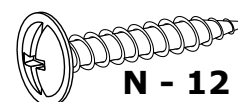

N - 12 St.
4x27 mm



E - 70 St.

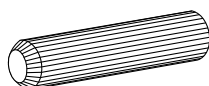

B - 32 St.

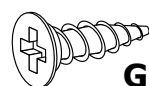

G - 28 St.
3,5x16 mm

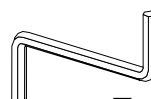

Z - 1 St.



L - 32 St.

I

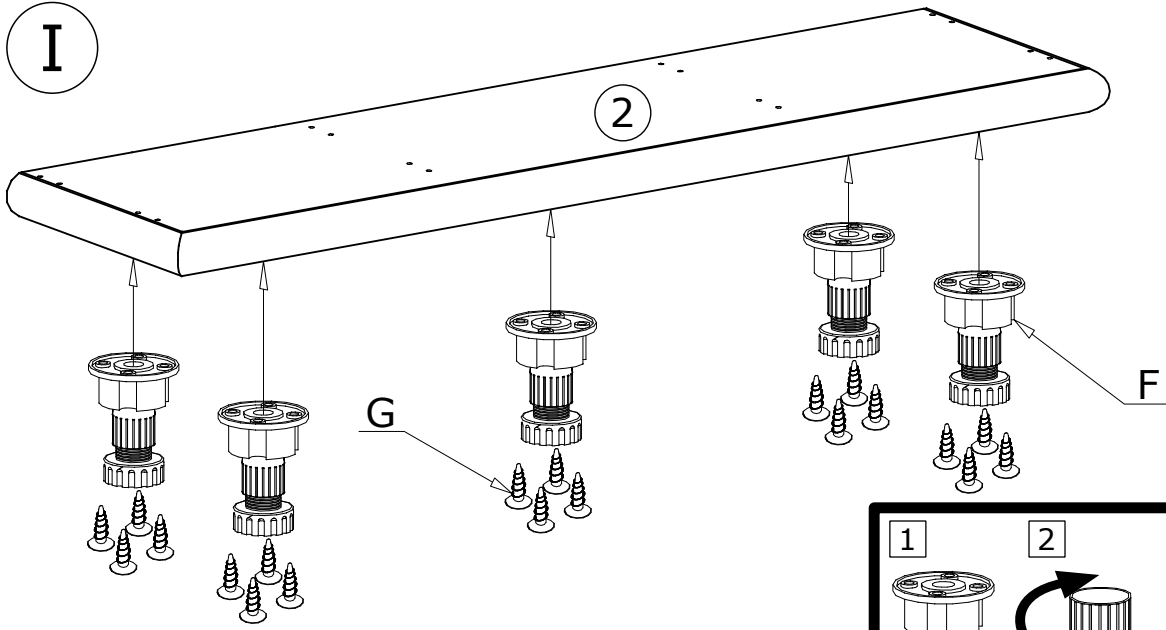

II

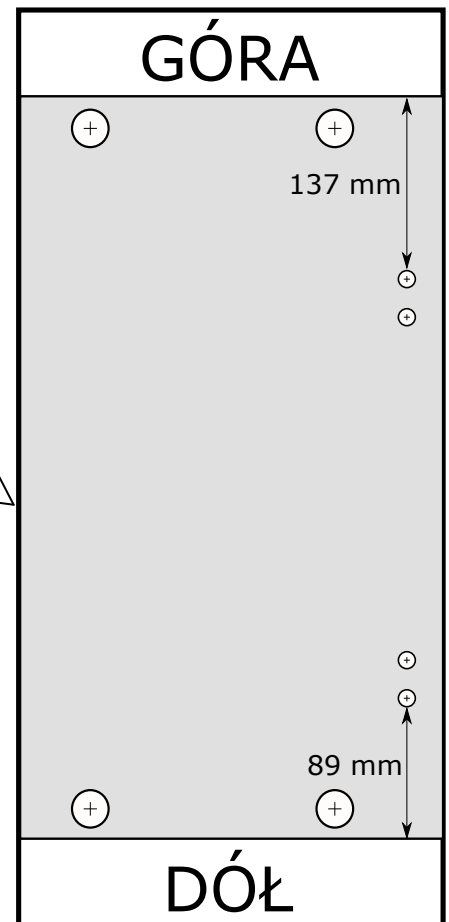
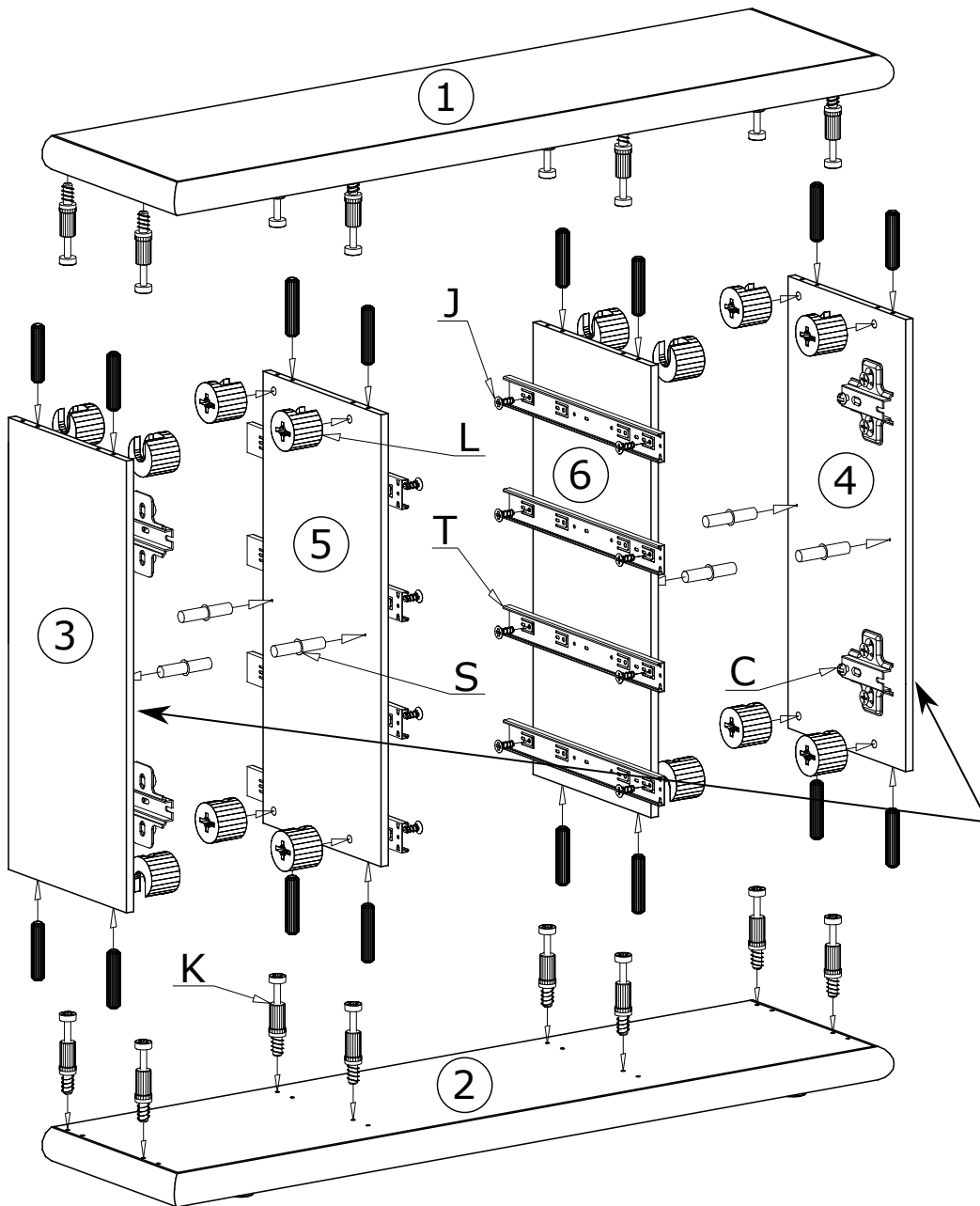
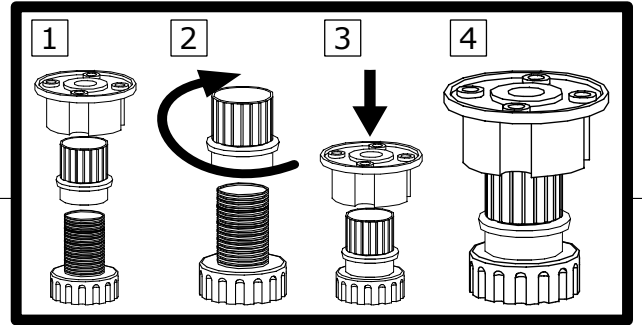

III

70X 

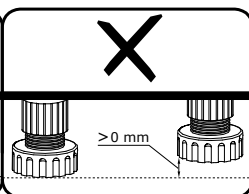
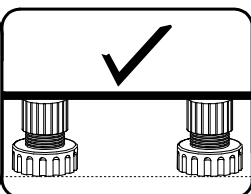
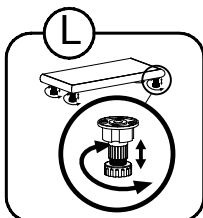
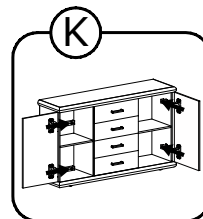
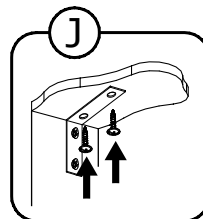
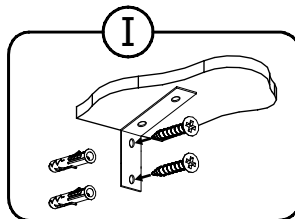
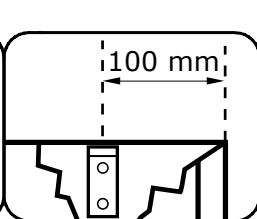
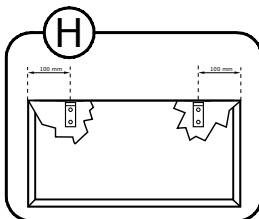
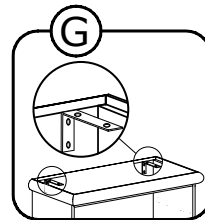
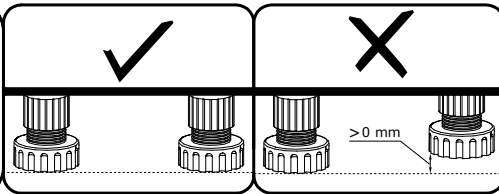
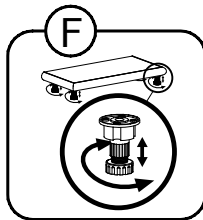
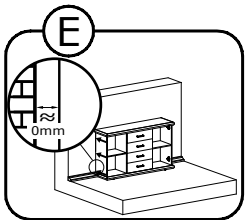
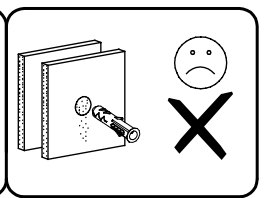
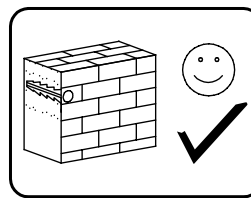
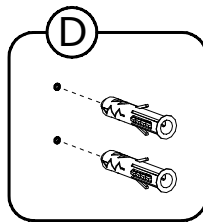
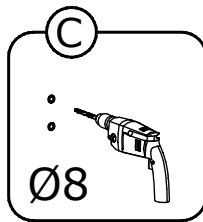
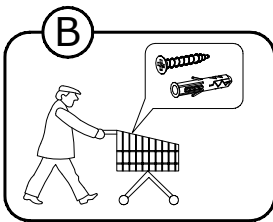
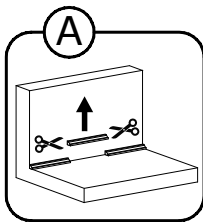
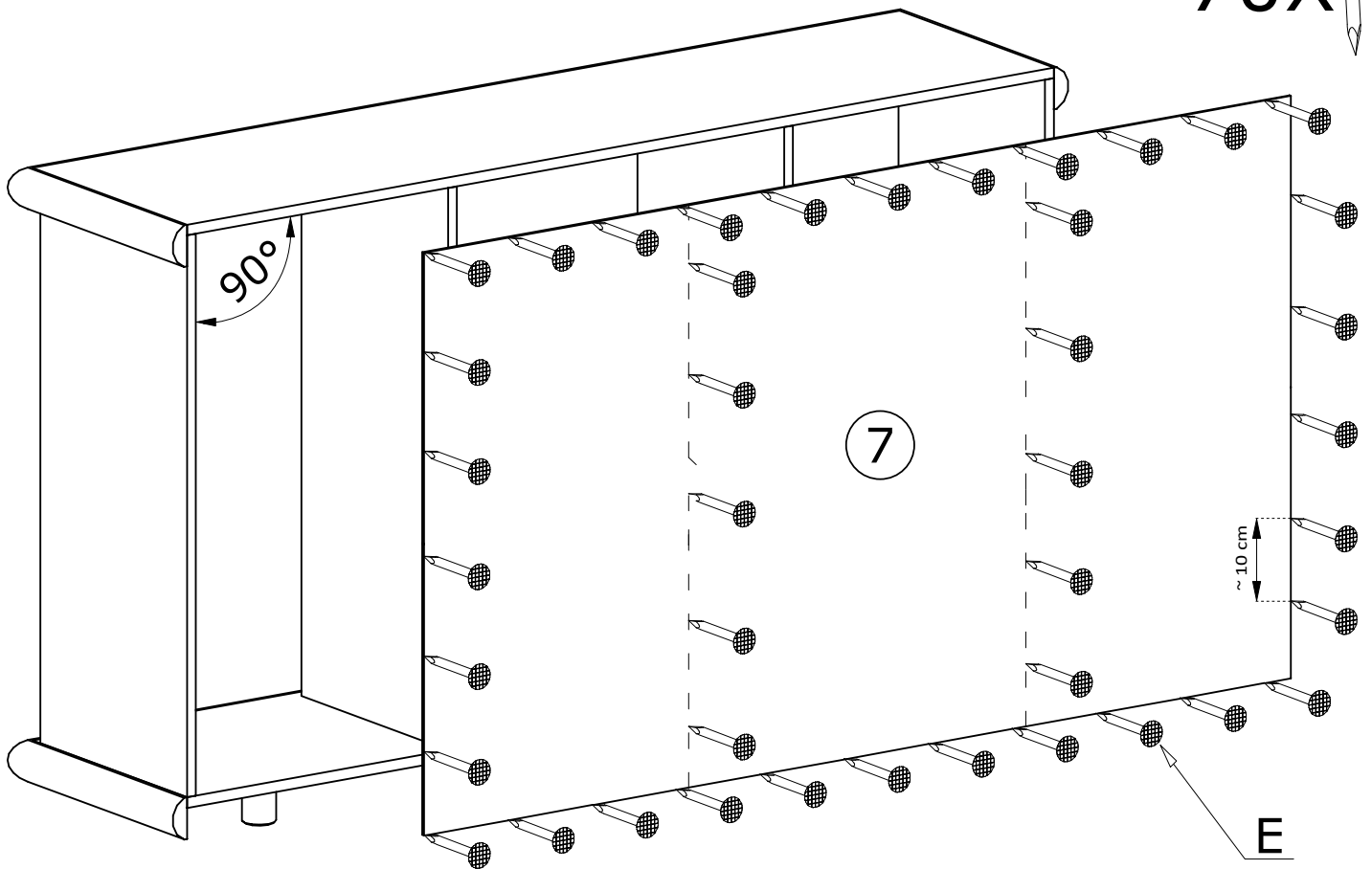

IV

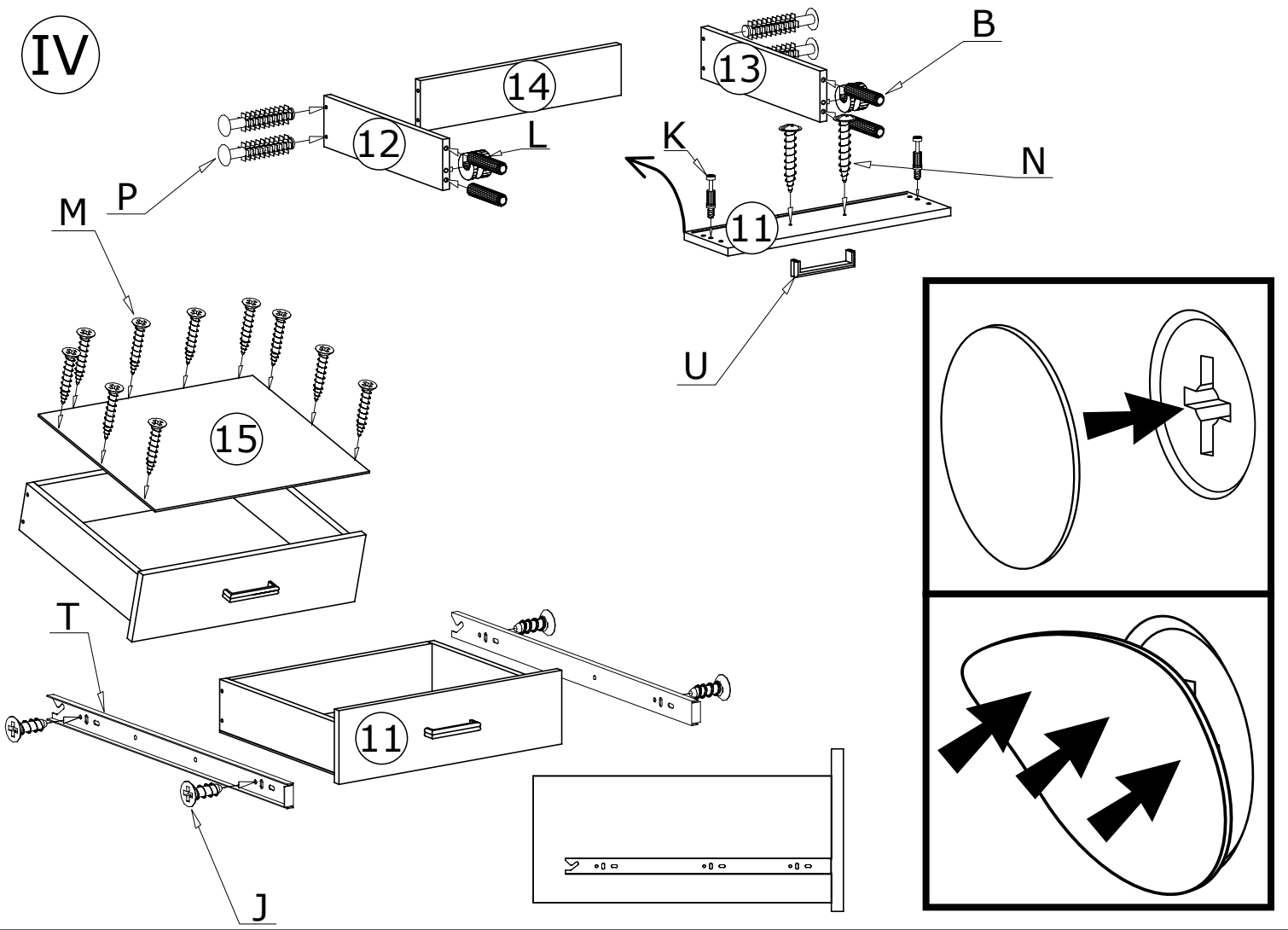

V

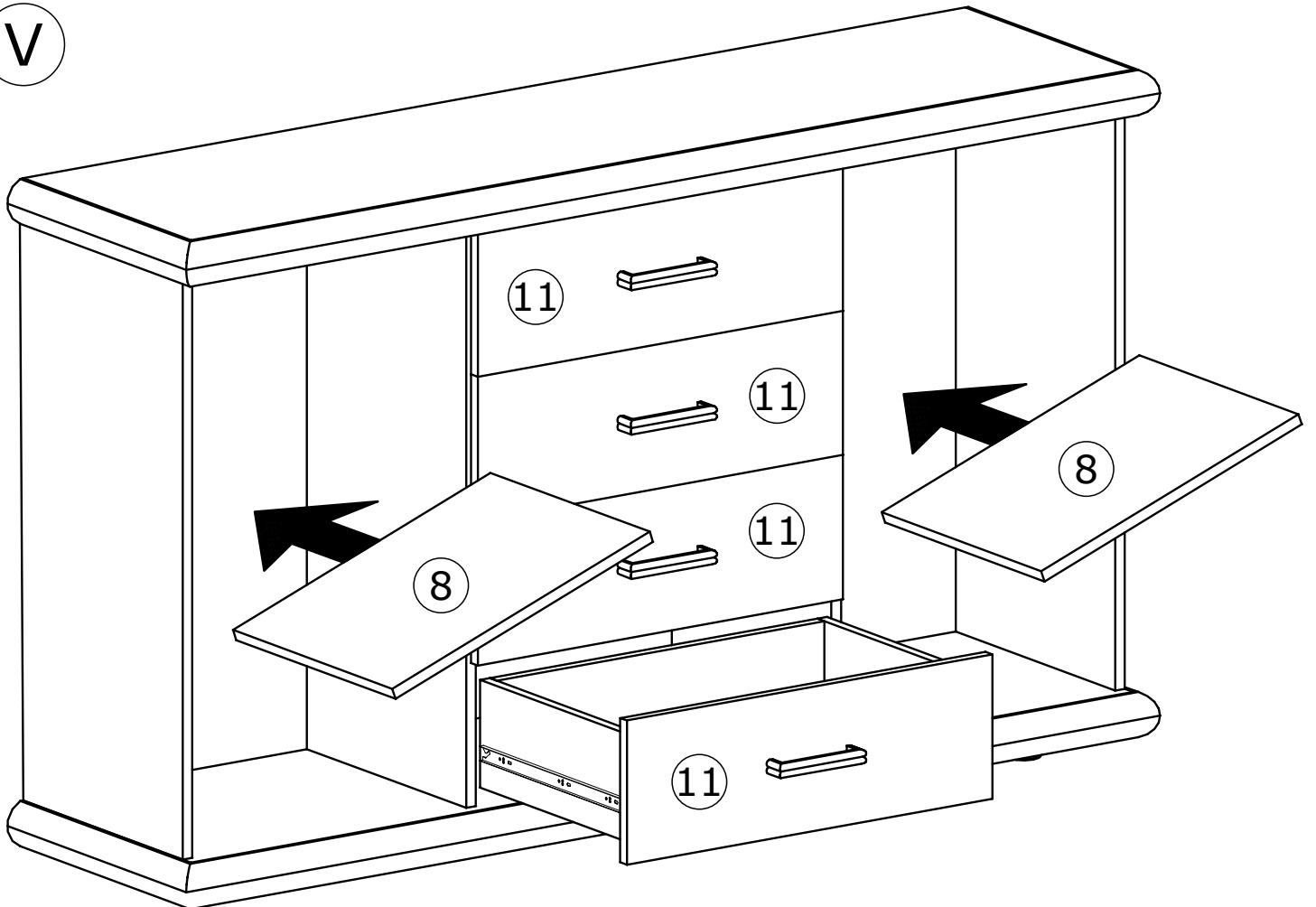

VI

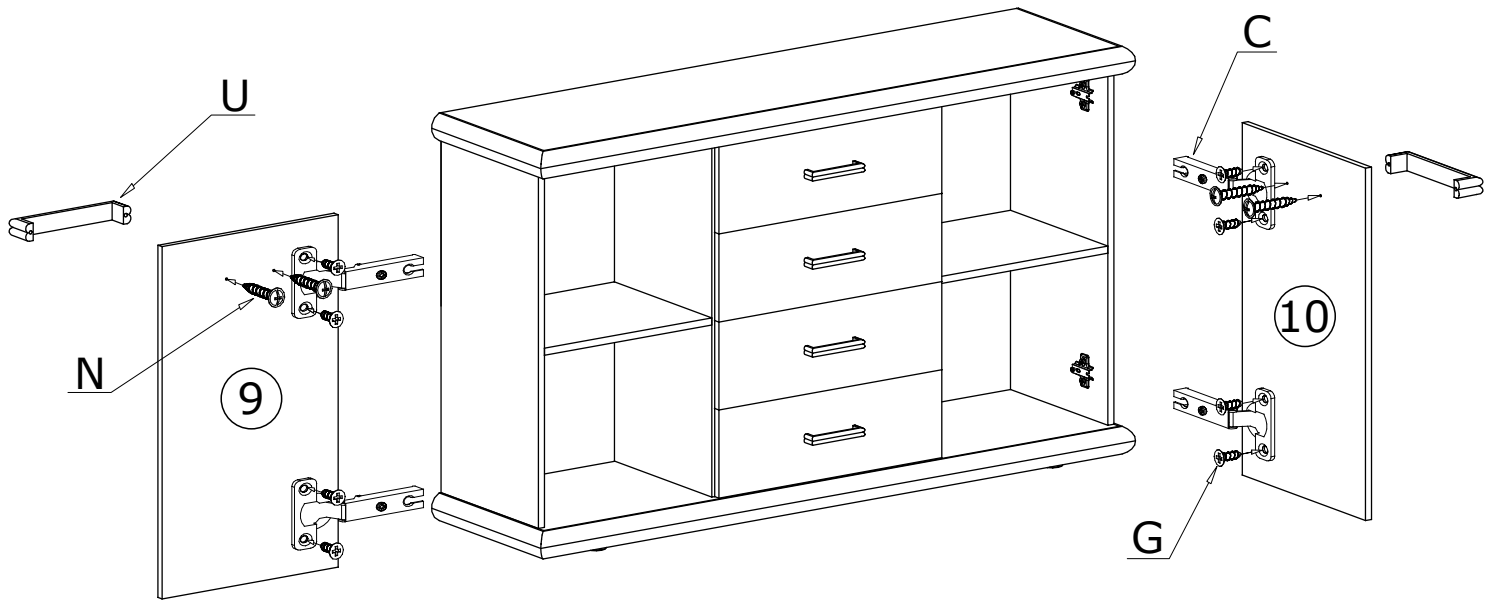

Meble zawierają elementy drewniane, których barwa i układ słoju są uzależnione od wielu czynników, dlatego mogą występować różnice w fakturze i barwie co nie stanowi wady produktu i nie wpływa na jego jakość, trwałość i funkcjonalność.

Listwy drewniane mogą ujawniać niewielkie zmiany w kształcie i wymiarach wywołane specyficznymi warunkami eksploatacji takimi jak: wilgotność, różnice temperatur, etc.

MONTAŻ/DEMONTAŻ PROWADNIC

1

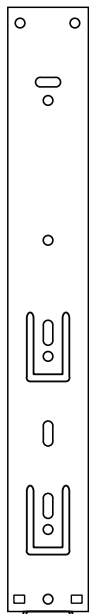

2

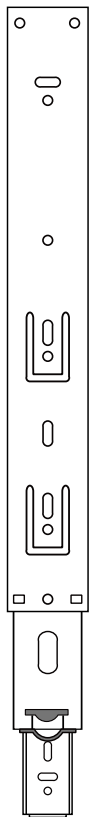

3

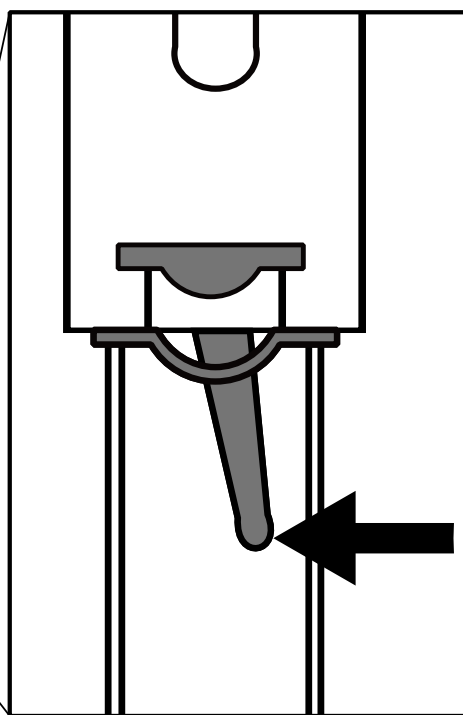
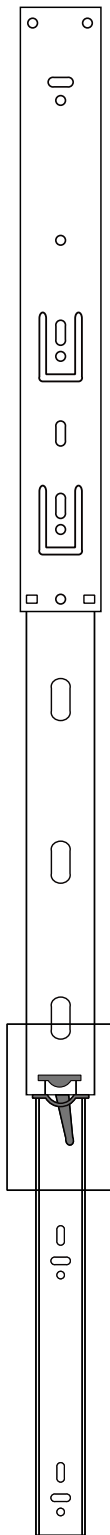

4

