

NATURAL 20

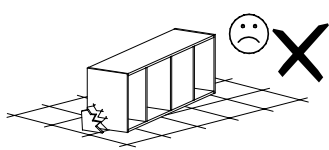

Narzędzia potrzebne do montażu

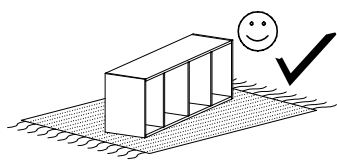
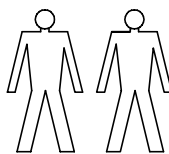
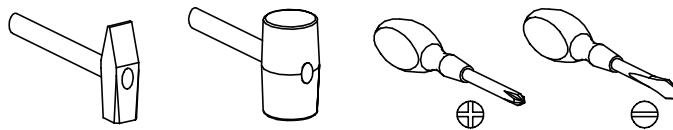

UWAGA !!!

MONTOWANIE USZKODZONYCH
ELEMENTÓW POWODUJE UTRATĘ
GWARANCJI

Nr	D[mm]	S[mm]	G[mm]	Ilość
1	1200	650	48	1
2	520	85	16	2
3	520	100	16	2
4	520	100	16	2
5	1164	100	16	2
6	1164	614	16	1

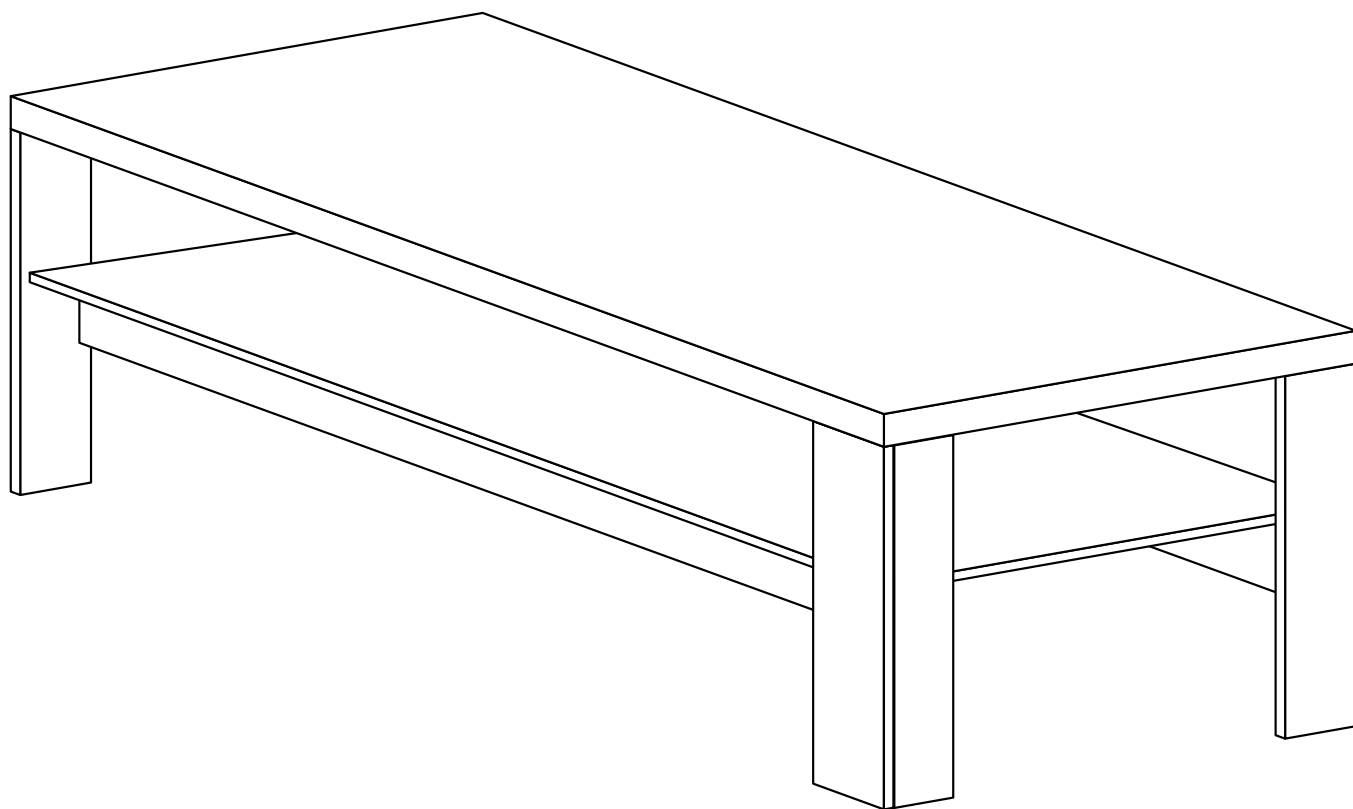

UWAGA !!!

Mebel zawiera
elementy drewniane

W przypadku reklamacji proszę podać numer pakowacza znajdujący się na kartonie.

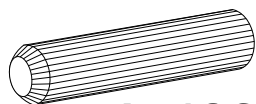

A - 16 St.

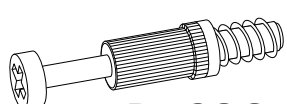

B - 26 St.



C - 26 St.

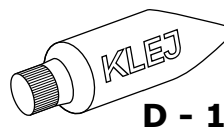

D - 1 St.

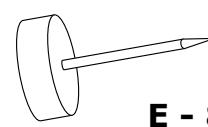

E - 8 St.

I

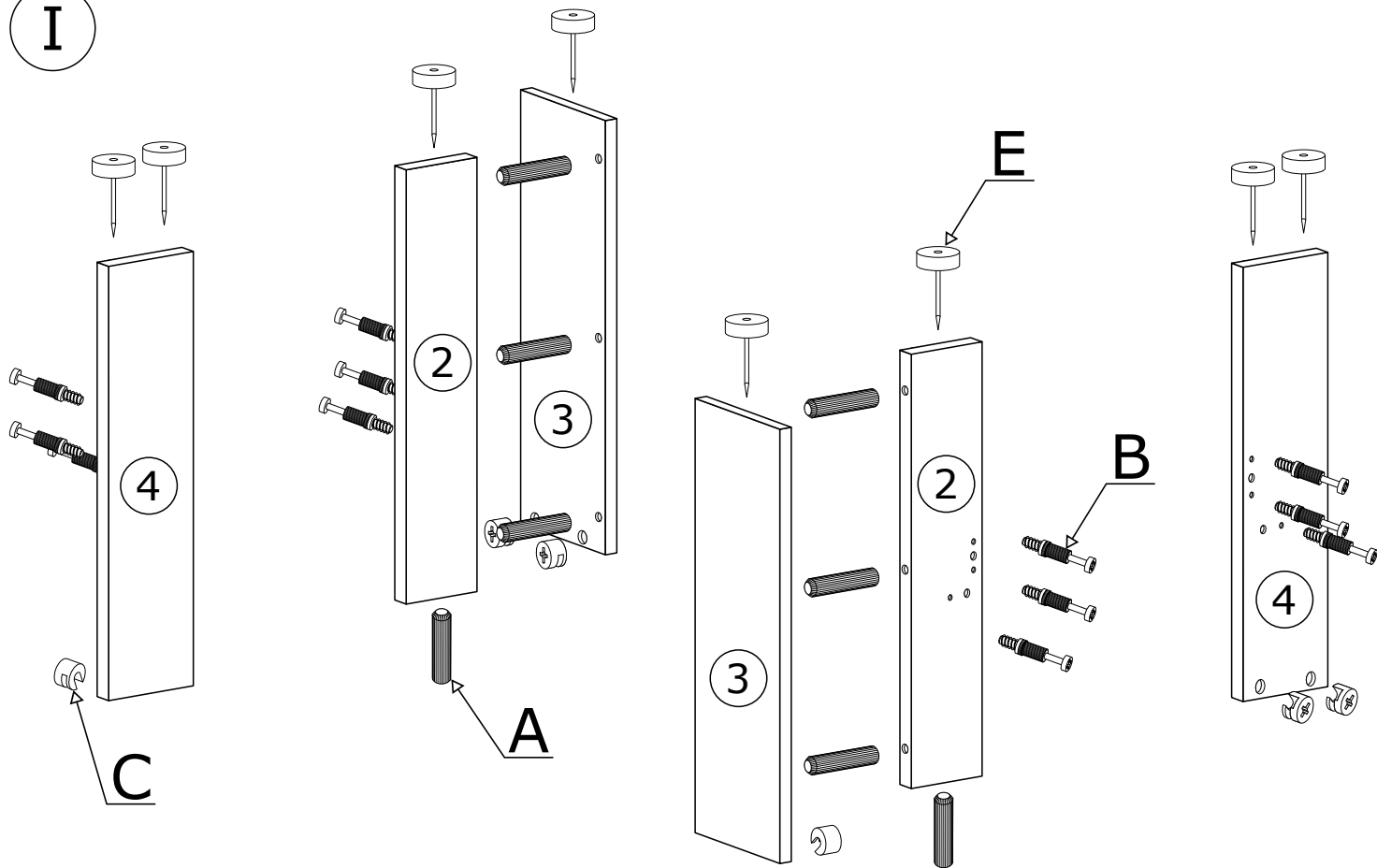

II

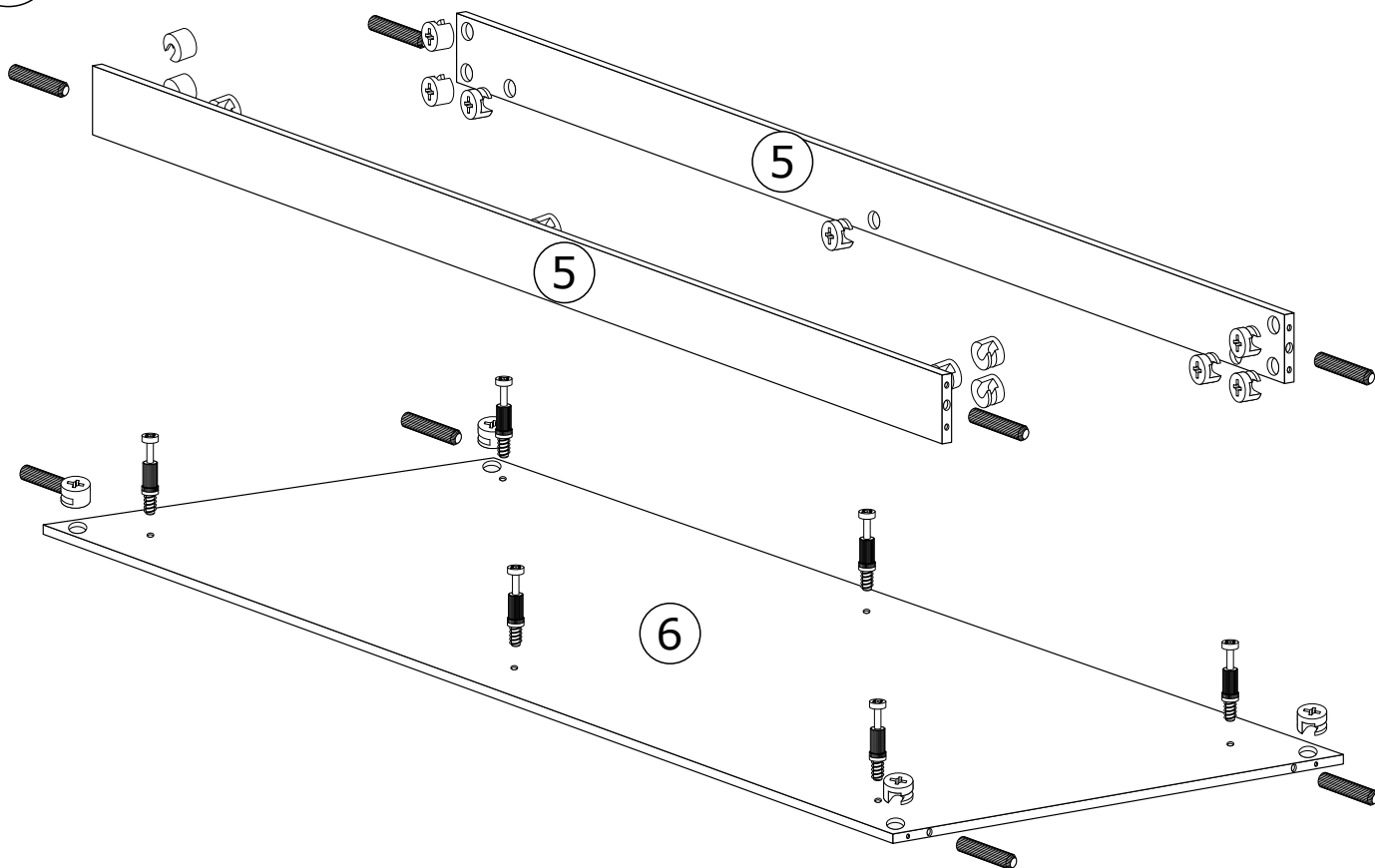

III

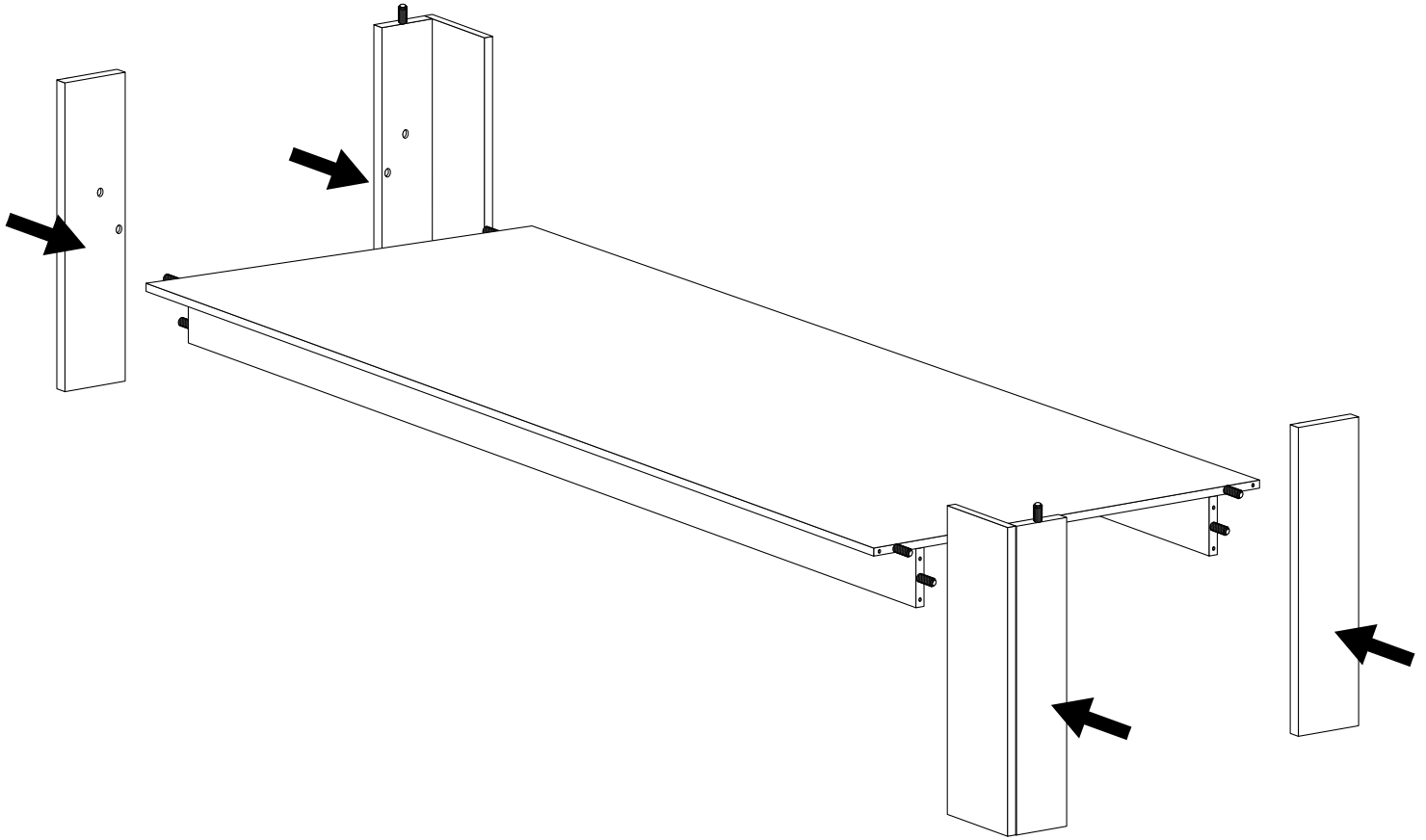

IV

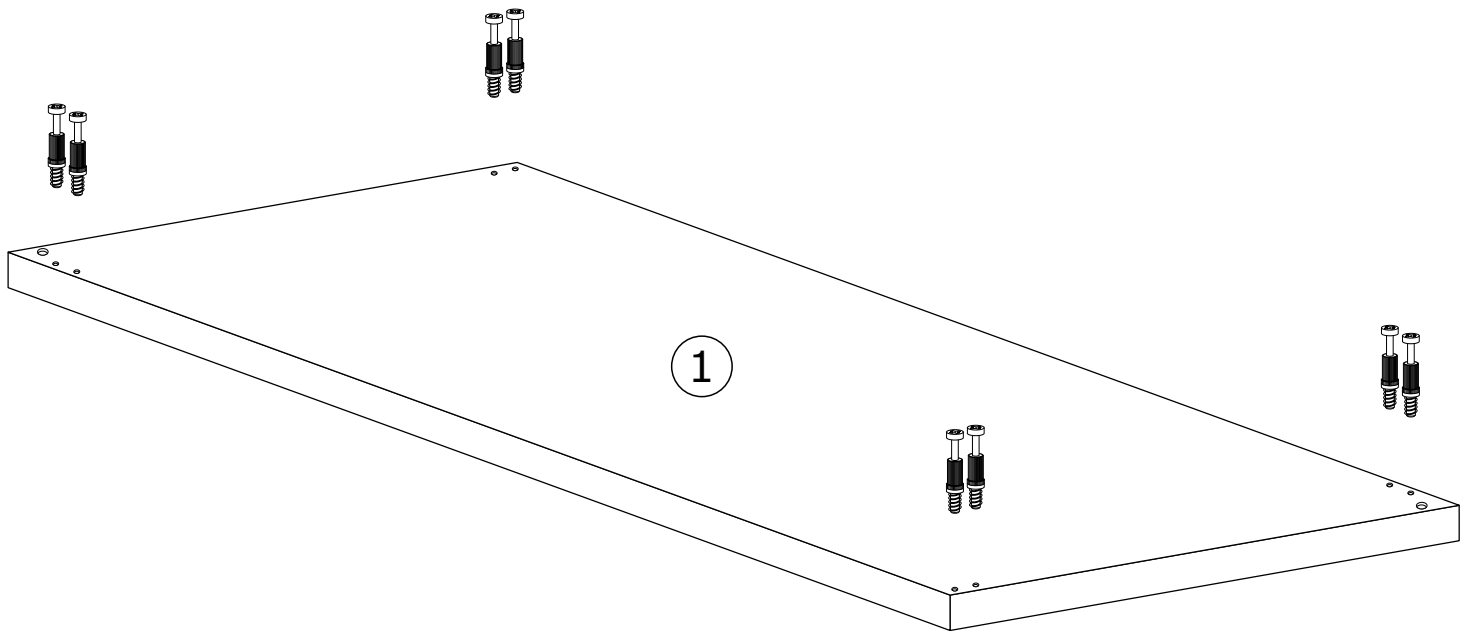

V

